

— CIA —
FIELD-EXPEDIENT
KEY CASTING
— MANUAL —

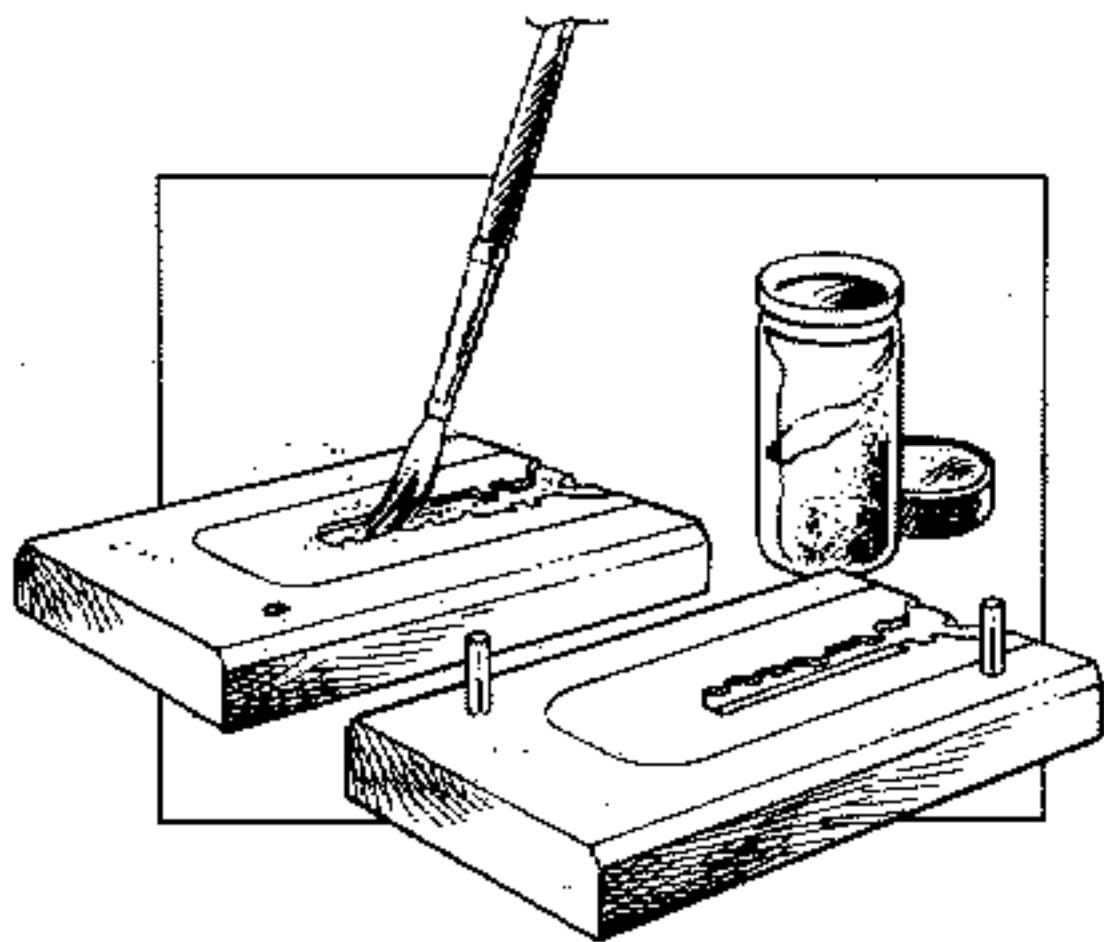

Key Casting

Have you ever wondered how the CIA agent gets behind locked doors when he is in the field, far from the locksmith shop? This manual, a revised reprint of the classic *CIA Key Casting Instruction Manual*, will teach you how to make a duplicate key when you can keep the original only a very short time. This step-by-step, self-checking manual guides you through the process of preparing the casting mold, making an accurate key impression, and casting the key model, using a standard issue or improvised casting mold and other readily available materials. The finished key can then be duplicated out of brass or steel on a regular key machine.

The straightforward text and clear illustrations of this updated manual give you the tools you need to create accurate duplicate keys to gain access to off-limits areas without special equipment.

A PALADIN PRESS BOOK

ISBN 0-87364-495-6

CONTENTS

Introduction	1
The Key Casting Kit	3
Preparing the Mold.	5
Making the Key Impression	11
Casting the Key.	21

CIA Field-Expedient Key Casting Manual

Copyright 1988 by Paladin Press

ISBN 0-87364-495-6

Printed in the United States of America

Published by Paladin Press, a division of
Paladin Enterprises, Inc., P.O. Box 1307,
Boulder, Colorado 80306, USA.
(303) 443-7250

Direct inquiries and/or orders to the above address.

PALADIN, PALADIN PRESS, and the "horse head" design
are trademarks belonging to Paladin Enterprises and
registered in United States Patent and Trademark Office.

All rights reserved. Except for use in a review, no
portion of this book may be reproduced in any form
without the express written permission of the publisher.

Neither the author nor the publisher assumes
any responsibility for the use or misuse of
information contained in this book.

Illustrations by Bill Border.

HOW TO USE THE KEY CASTING KIT

This manual is a reprint of the CIA Key Casting Instruction Manual. The text is straightforward, and the instructions are self-testing and step-by-step. New illustrations and a few items of explanation have been added to clarify the process of using the kit.

The casting medium recommended is Cerrosafe, which is used as a chamber casting medium and is available from distributors of firearms supplies such as Brownells, Inc. It shrinks about one percent after cooling so that it will slip from the chamber of a rifle, and makes an excellent cast. The slicer used here is a common cheese slicer, which can be found at any housewares store. The candles are common party or camping candles. A thimble with a twisted wire handle can be used as a casting cup. The rest of the items are standard stock items.

The mold illustrated here is issued in aluminum, but it can be handmade from hardwood or plastic or built in layers of aluminum sheet metal and pinned to final size. The mold illustrated measures 4" x 2 1/2" x 1"; the cavity for the clay is 3" x 1 1/4" x 1/4". The mold will cast all keys, including the modern Medeco and high-security type. The finished key can then be duplicated on a regular machine or hand filed. The cast key may be used in a lock if it is assisted with a turning wrench lock-picking tool. Flash or metal ooze must be scraped or filed away to the correct tolerance and key dimensions. The kit will cast anything it can physically hold and, as an adjunct, is useful in making impressions of high-tech components, script, bullets, and the like.

THE KEY CASTING KIT

The KEY CASTING KIT will enable you to make a duplicate key when you can keep the original key only a very short time.

In using the kit, you first make an impression of the key by pressing it in a mold between two layers of clay. Then you make a casting of the key by pouring low-melting-point metal into the impression. The low-melting-point metal, when cooled, is quite soft, so that ordinarily you have to make a hard metal (brass or steel) key from the casting before attempting to open a lock.

This book is carefully designed to teach you how to cast a key. It takes you, step-by-step, through the process of (1) preparing the mold for the key impression; (2) impressing the key on the clay of the mold; and (3) casting a model of the key in soft metal. The kit will not enable you to make a brass (or steel) key; that must be done with other equipment.

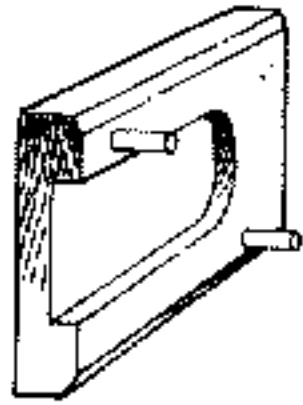

A

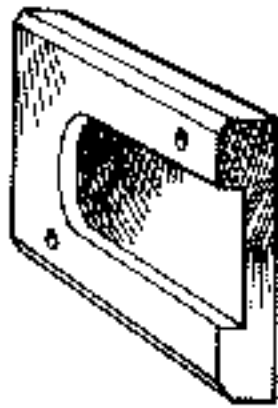

If your mold is not filled with clay (as in A), and you wish to learn how to prepare the mold, turn to the next page.

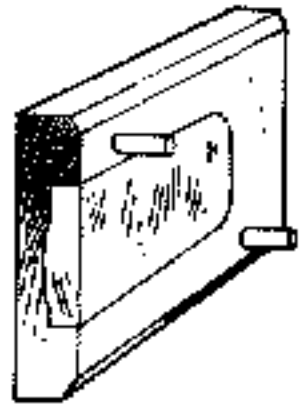

B

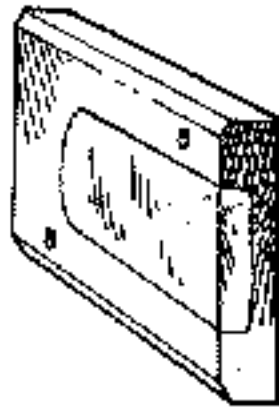

If your mold is prepared for use (as in B), and you wish to learn how to make a key impression, turn to page 11.

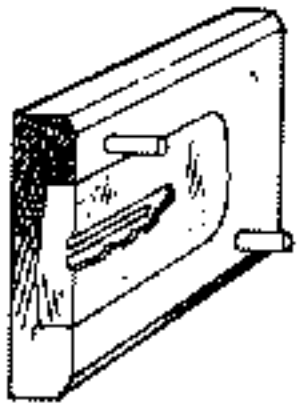

C

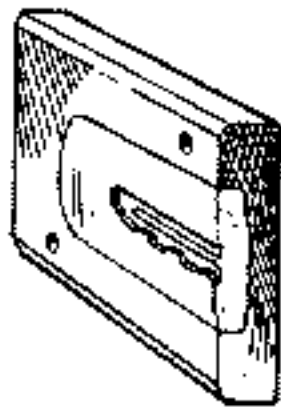

If you have a key impression (as in C), and you wish to learn how to cast the key, turn to page 21.

PREPARING THE MOLD

What you need:

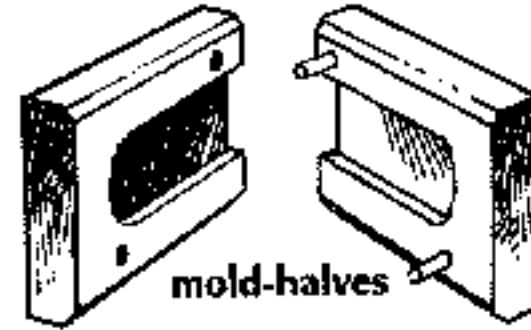

mold-halves

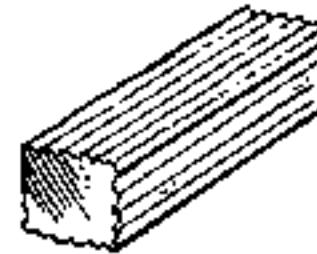

clay



scraper



artist's brush

talc



slicer

Do you have all of these? Then turn the page.

What you do:

Cut the clay in half lengthwise.

Warm one of the clay halves in your hands.

Place the warmed clay in the mold-half with pins.

Press down with your thumbs.

Work the clay into all parts of the mold-half.

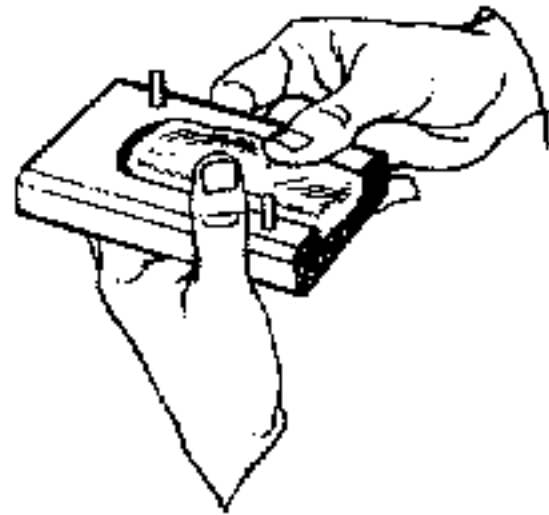

Avoid overlapping segments of clay.

DO press down

DON'T overlap segments of clay

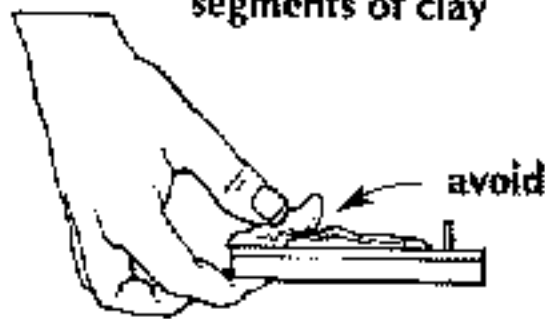
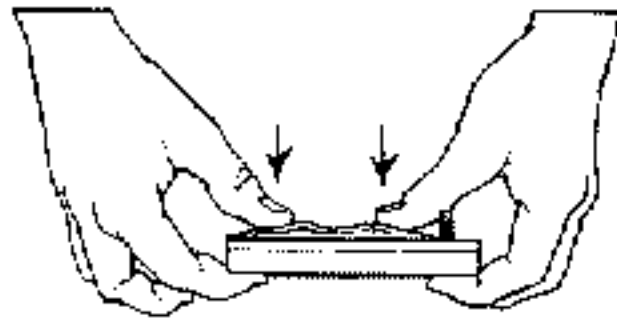

The purpose in avoiding overlap is to avoid forming cracks in the clay. The clay should be crack-free, so it will not flake or chunk apart.

If you do overlap segments of clay, just keep pressing down with your thumbs and the crack you made will eventually blend away.

When ready, turn page.

Your mold-half should look like this:

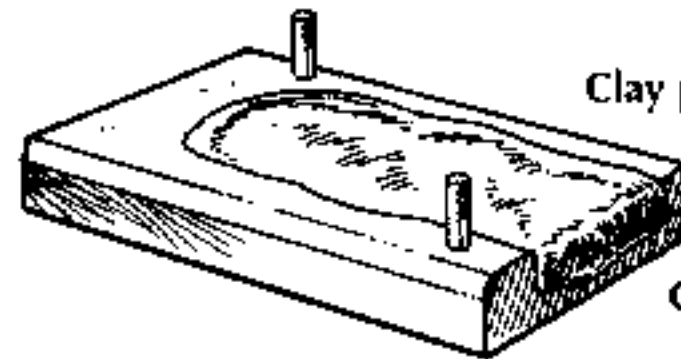

Clay protrudes above mold.

Clay juts beyond mold.

Next, take the slicer and slice off the excess clay (top surface only).

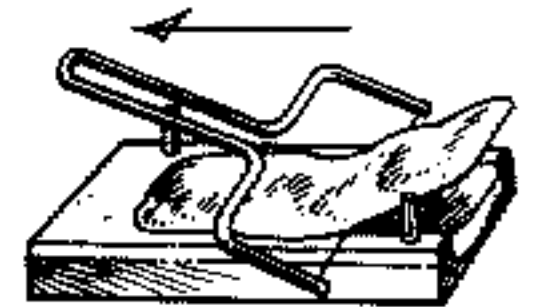

Slicing around the pin is a problem. Be careful not to gouge out clay below the level of the mold-half face.

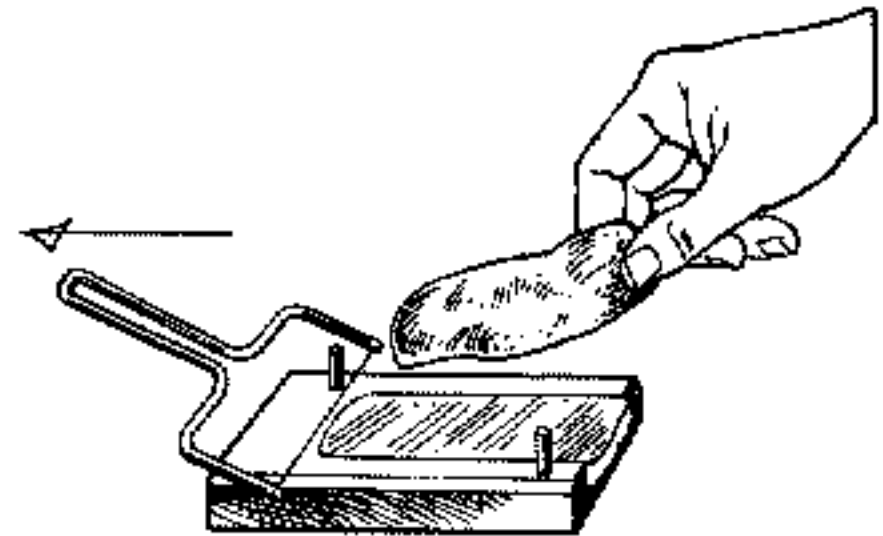

When you have sliced off the excess clay from the top surface of the mold-half, turn the page.

Your mold-half should now look like this:

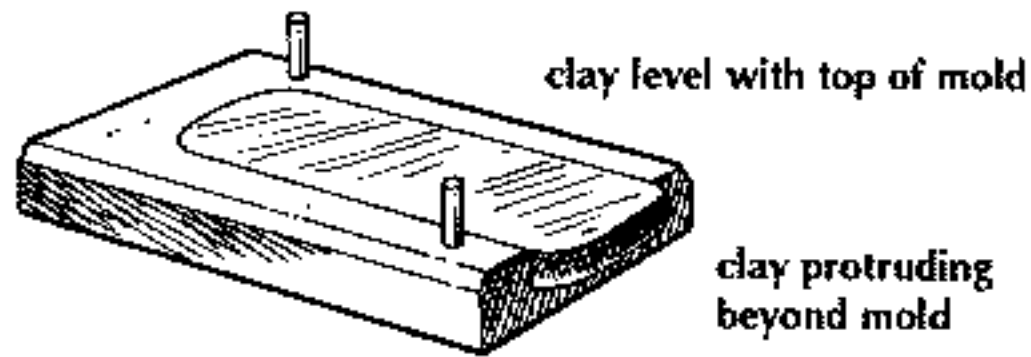

Next, scrape several times with the scraper, to remove excess clay.

Keep scraper vertical.

Move toward rounded end.

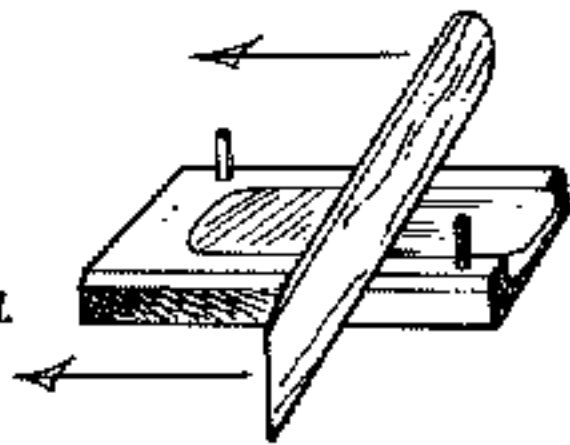

Now fill, slice, and scrape the *other* half of the mold. Then, turn the page.

NOTE: If the scraped surface flakes off, develops holes, or otherwise is not perfectly smooth, you should not add lumps of clay directly to the surface itself. If you do, you will have to work hard with your thumbs to avoid future flaking. Instead, add a lump to the open end of the mold. By working this in, you will raise the general level of the clay surface and can quickly scrape again.

Your mold-halves should look like these:

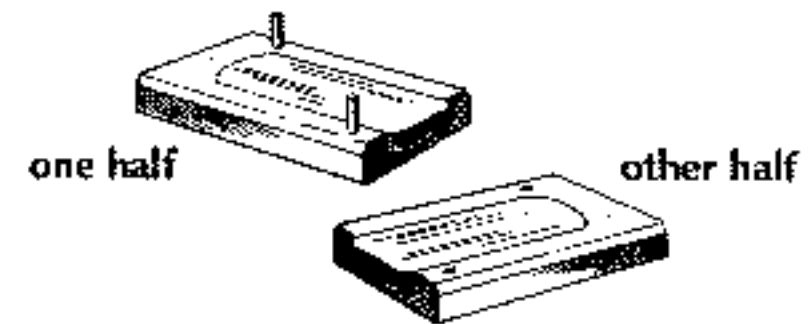

Now dust the clay of both halves with talc.

Brush on a thin layer.



Blow off any excess.

The dusting will prevent the clay from sticking when the mold is pressed together.

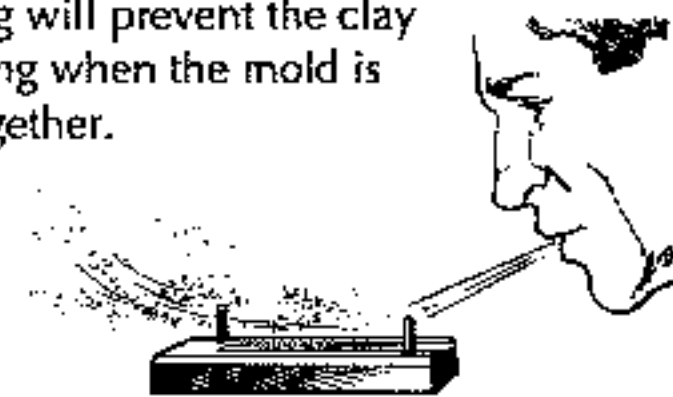

When you have finished dusting both mold-halves, turn the page.

Have you dusted *both* halves?
Next, put the mold together.

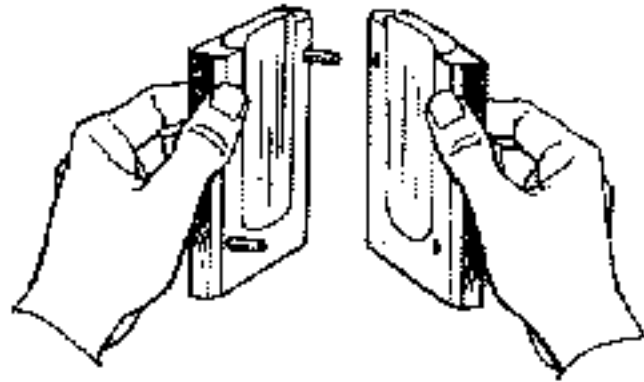

Caution: Be sure no traces of clay are on the metal surfaces of the mold that will be touching each other when the mold is put together. Otherwise the mold will not close tightly. Slice off the excess clay.

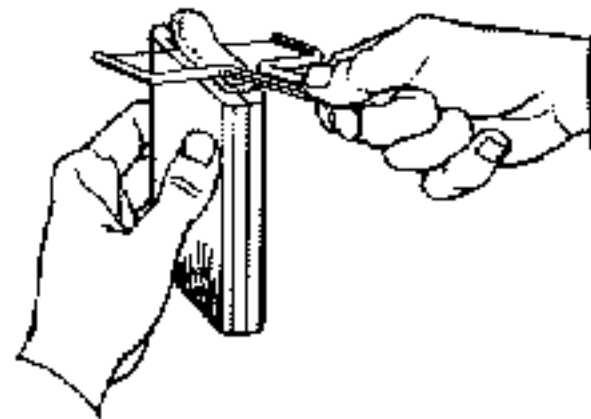
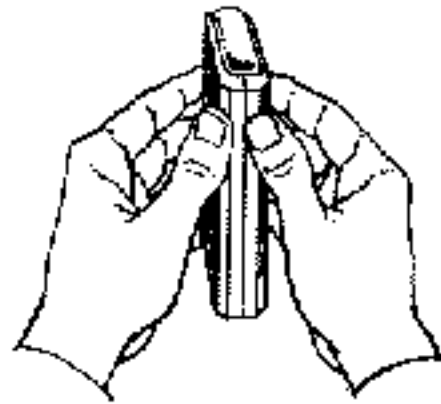

Dusting with talc isn't necessary this time.

You have now finished *preparing the mold* for the key impression. The next step is *making the key impression*.

Now, turn the page.

MAKING THE KEY IMPRESSION

What you need:

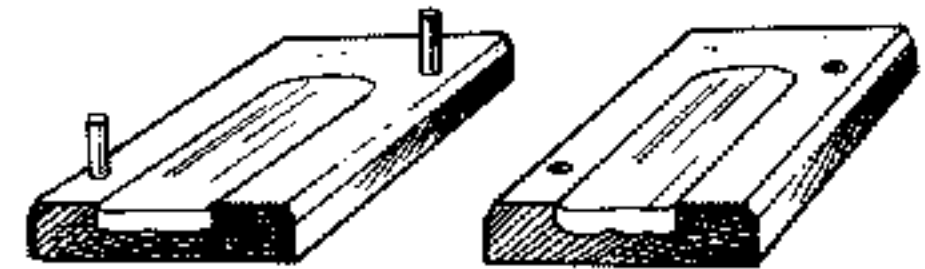

prepared mold-halves



talc



slicer

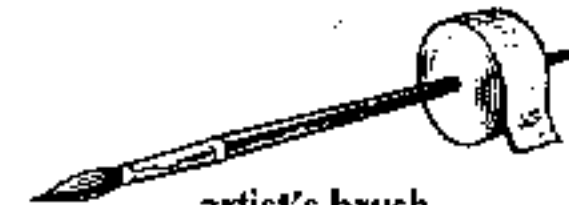

artist's brush

masking tape

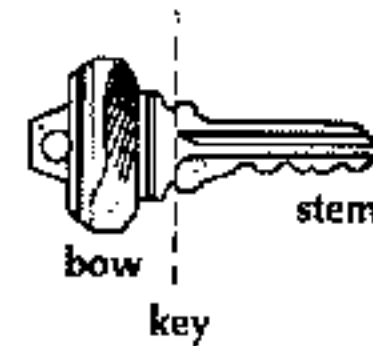

bow

stem

key

Do you have all of these? Then turn the page.

What you do:

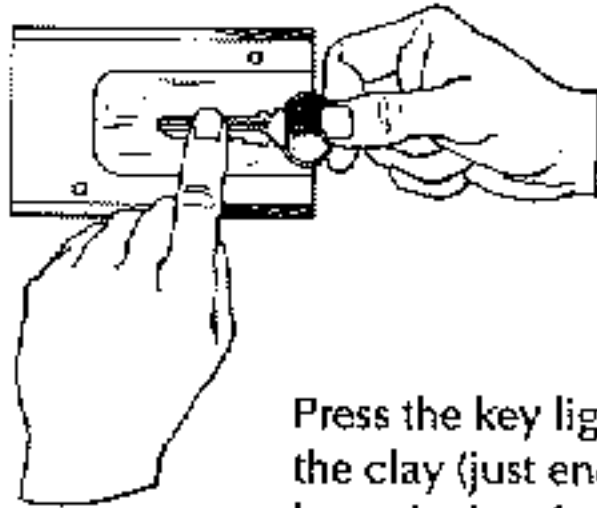

Press the key lightly onto the clay (just enough to keep the key from sliding off).

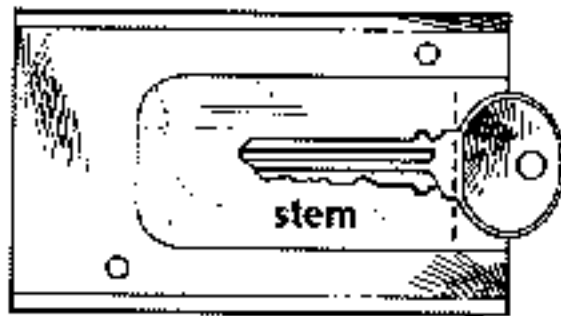

bow

Allow about half of the bow to rest on the clay.

NOTE: If you are casting a lever-lock key, it may be too long for you to put half of the bow in the mold. In this case, cast what you can.

The purpose of putting just half of the bow of the key on the half-mold surface is to allow enough of the key to extend beyond the mold so that there will be something to hold on to when it comes time to lift the key from the half-mold. Why not leave the whole bow outside? Because the more of the key you cast, the more information about the key you will be recording in the casting, and the easier the key will be to duplicate.

Your mold-half and key should look like this:



Now place the other half of the mold down over the guide pins . . .

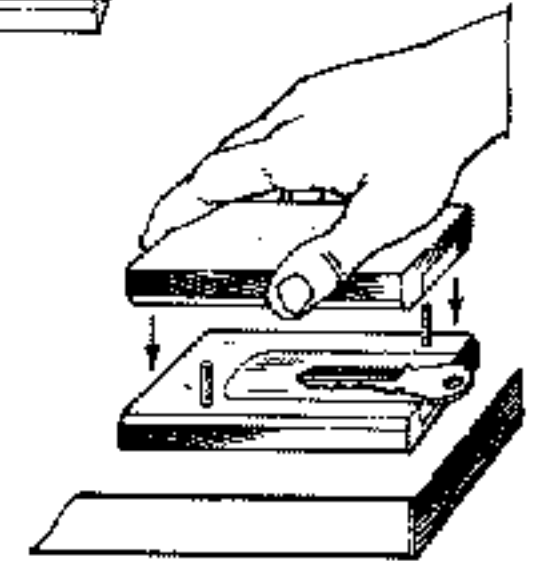

CAUTION:



right



wrong



. . . and press the two halves firmly together. Press tightly for several seconds, so the clay will be less likely to spring back toward the center of the mold.



Standing on the mold works nicely.

Place the mold upright on a table, and *carefully* pull the halves apart.

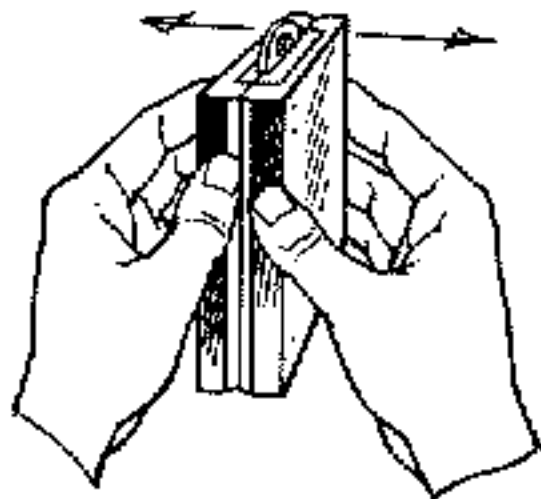

NOTE: If the mold does not come apart easily, loosen the halves by gently working your thumbs and fingers alternately in the grooves between the mold halves.

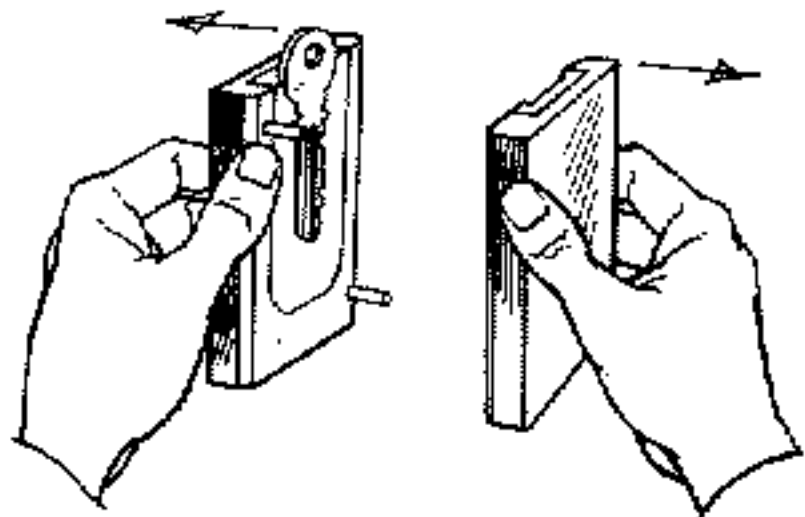

Then put the halves down, clay side up.

The purpose in being so careful is to avoid damaging the impression.

The next step is to lift the key from the mold.

What you do:

Gently loosen the key by *slightly* twisting it.

Then lift it *straight up*.

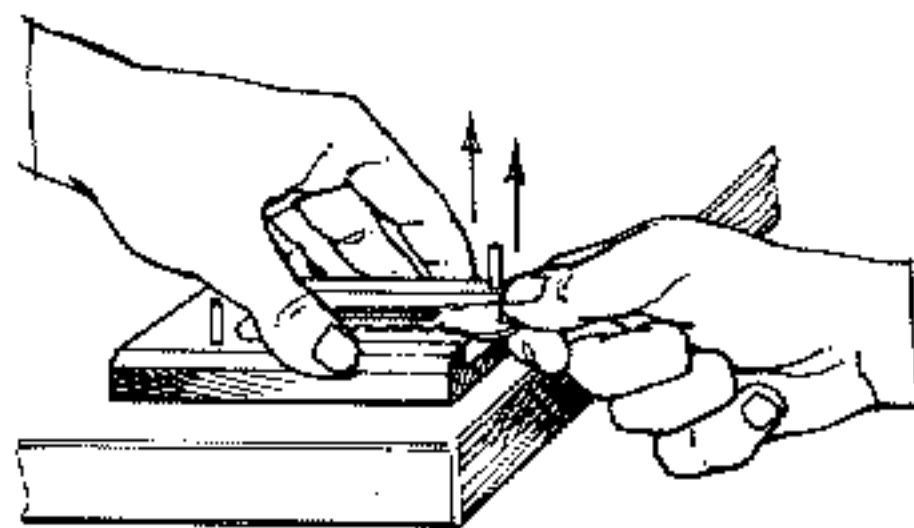

The purpose in twisting the key only *slightly* and then lifting the key *straight up* is to avoid damaging the impression.

Practice will help.

Examine both halves of the key impression.

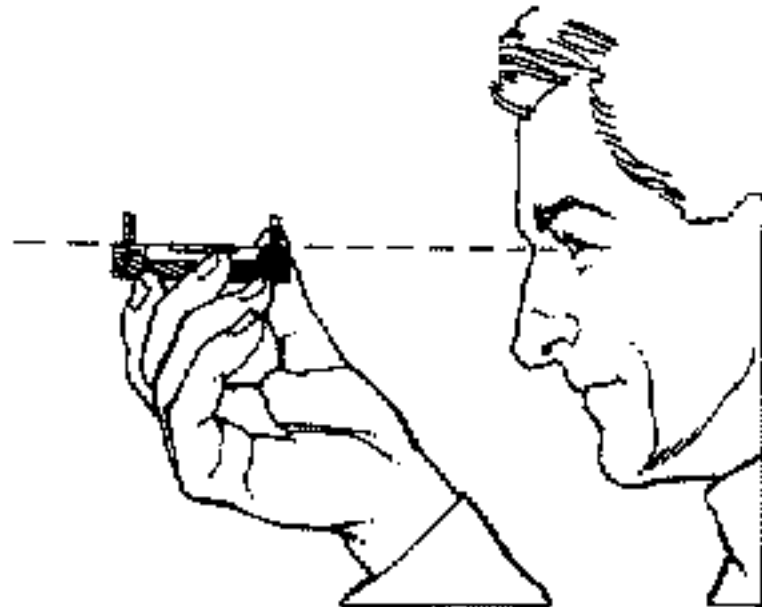

Can you find raised edges in either half of the impression?

raised edges

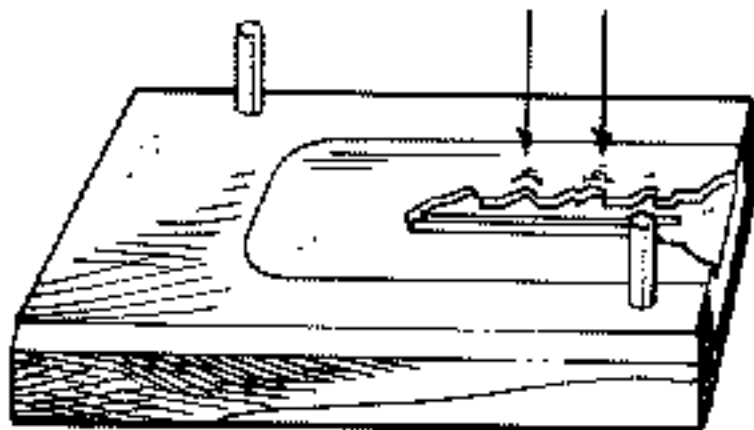

If so, what probably caused them?

After you have decided on your answer, turn the page.

Among the causes of a raised edge are:

- 1) Twisting the key too much while loosening it;
- 2) Pushing or pulling the key while loosening it;
- 3) Not lifting straight up.

Perhaps yours, however, was caused in some other way.

If you could find no raised edge, you are doing well.

Why is it important to avoid causing raised edges?

After you have decided on your answer, turn the page.

Why avoid raised edges? Because a raised edge means that the duplicate key may not be exactly like the original key.

If a duplicate key is off by only the thickness of this piece of paper, it may not open the lock.

After lifting the key from the mold, the next step is to make a funnel in the clay through which the molten metal can flow.

Using the slicer, cut away a bit of clay from each half of the mold. When put together, the two pieces should make a funnel, shaped like a cone.

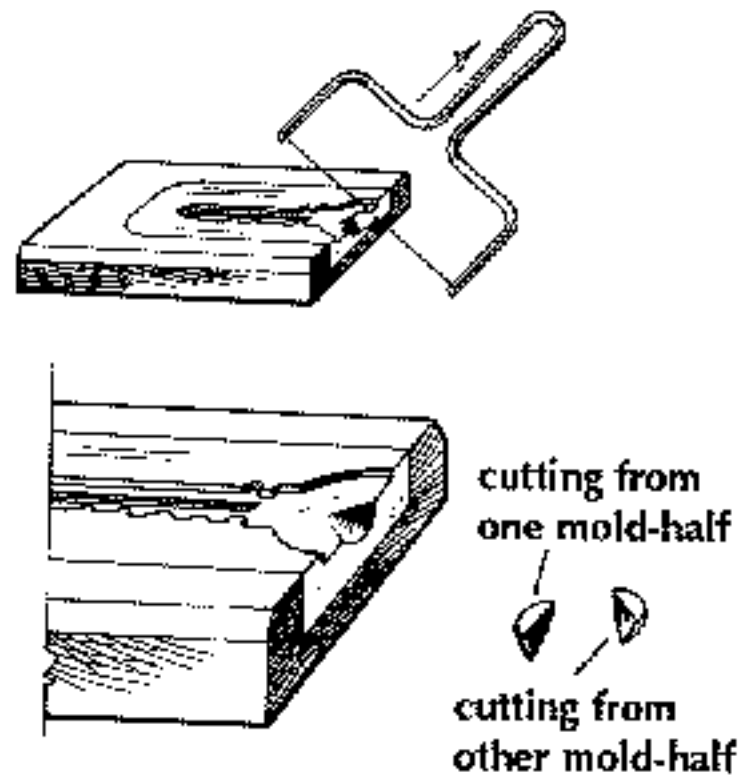

NOTE: The cuttings should be at least as large as shown above (1/4" in diameter).

The purpose of the funnel is to allow the metal to flow quickly into the mold.

You may prefer using a penknife or other implement.

Did you cut away clay from *both* halves of the mold?

The last step in making a key impression is to dust the impression and put the mold together.

Brush talc over *both* halves of impression and funnel.

Blow off any excess talc.

Then put the mold carefully together.

CAUTION:
Match funnel ends!

Now bind the halves together with masking tape (or strong rubber bands).

You have *prepared the mold*; you have *made a key impression*. The next step is to *cast a soft-metal model of the key*.

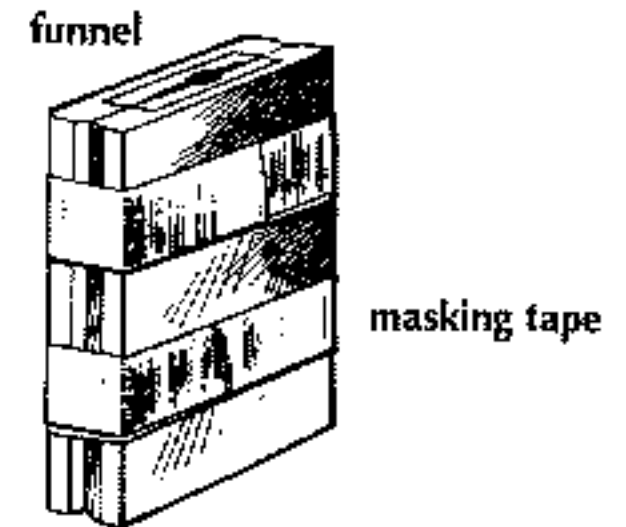
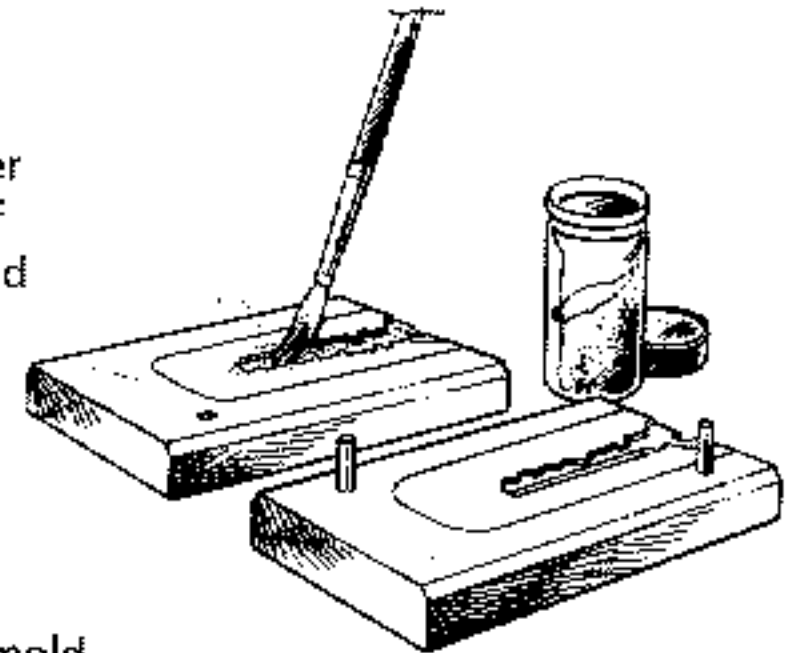

CASTING THE KEY

What you need:



alloy slug



mold with key impression

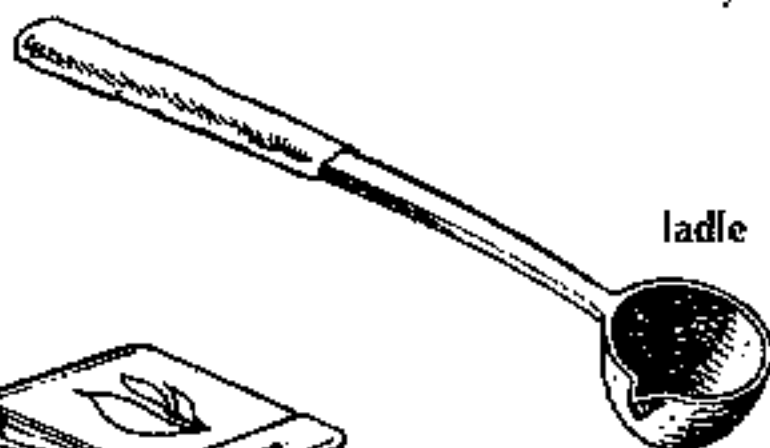

ladle



matches

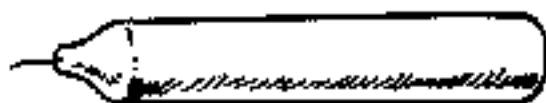

candle

NOTE: A stove, hot plate, torch, or other such heat-generating item, may be used in place of the candle and matches.

Do you have all five items? Then you are ready to . . .

Prepare the candle.

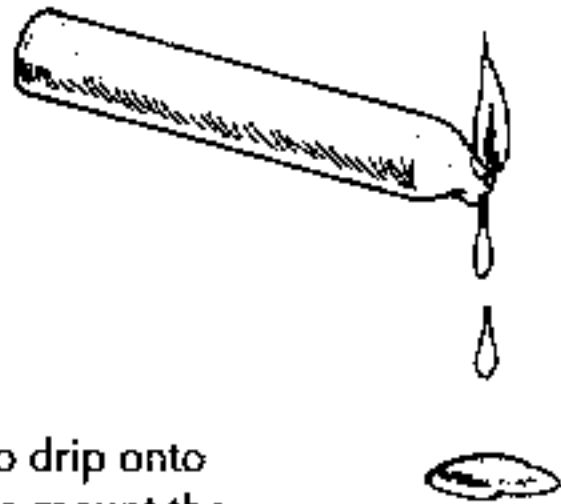

Allow a drop of hot wax to drip onto the spot where you wish to mount the candle.

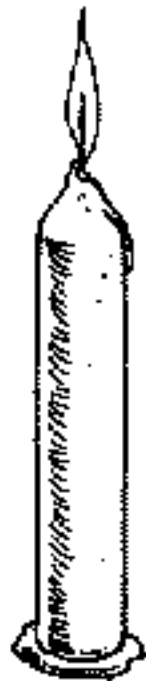

Then immediately place the candle on the drop of wax and hold it there firmly for three or four seconds to allow the melted wax to harden.

A candlestick would, of course, hold the candle in place equally well.

When your candle is firmly mounted, turn the page.

Now get set to time the heating of the metal.

If you have a watch, put it where you can see the small seconds dial.

If you do not have a watch, you can count the seconds aloud, speaking at a moderately fast pace ("One thousand and one, one thousand and two," etc.)

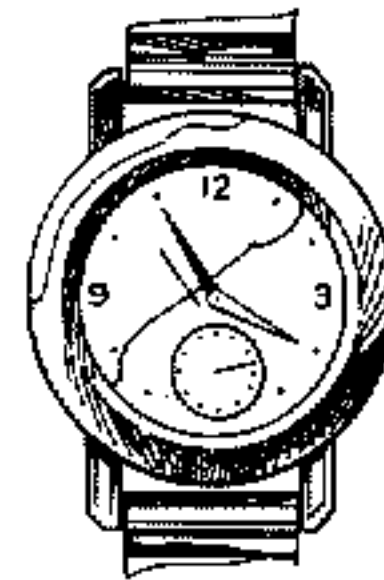

The purpose of timing the heating of the metal is to avoid 1) having the metal insufficiently hot so that it cools too rapidly in the mold (and so leaves unfilled portions) and 2) having the metal so hot that it softens the clay and blurs the impression. You can make mistakes either by *underheating* or *overheating* the metal.

If you are ready to time the heating of the metal, turn the page.

Now you are about to melt the alloy slug and pour a casting—the payoff for all your careful preparation.

But before you actually do it, let's go over the steps involved because, once you've started, one step follows another in quick sequence.

What you are to do (but not yet):

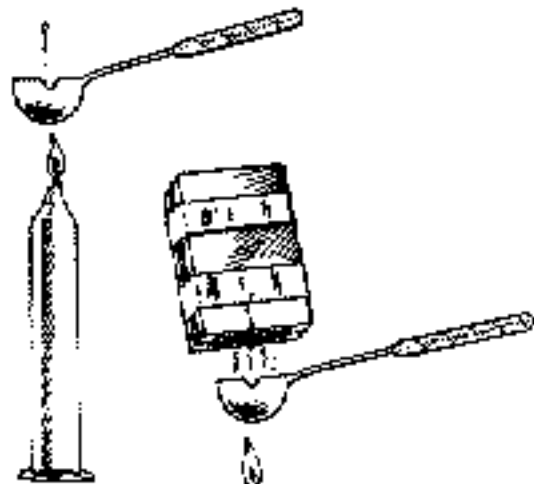

Melt the metal in the ladle over the candle flame. Heat it for about 30 seconds after it is melted.

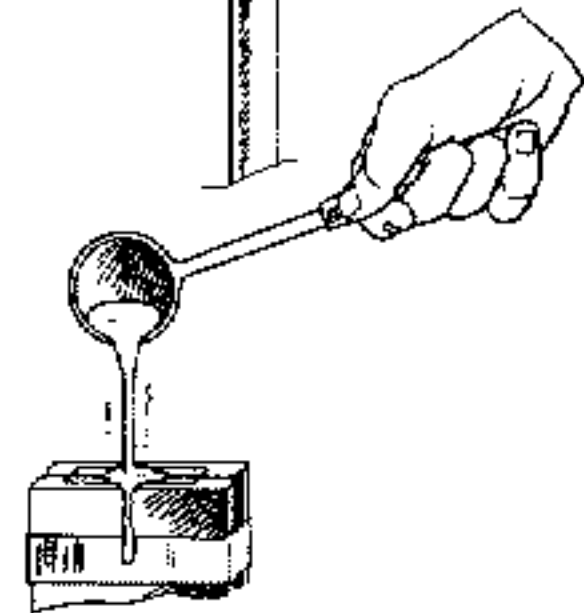

During the last 5-10 seconds of the heating, hold the mold upside down over the ladle. (This warms the inside of the mold enough to delay solidification until the metal can flow into the tiniest crevices.)

And, finally, pour the casting. NOTE: Keep your fingers away from spilling metal!

Now, turn the page.

Now you are ready to make your casting.

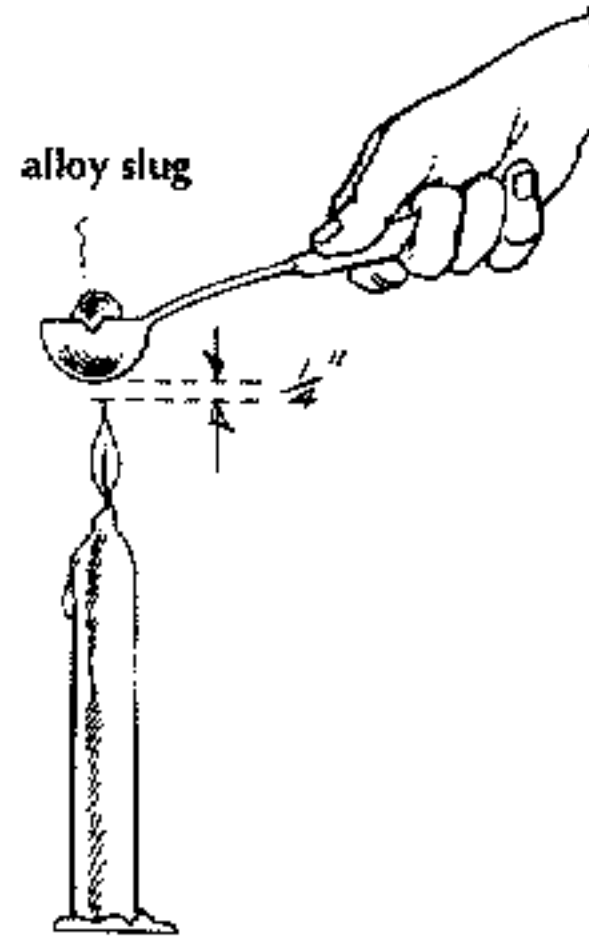

Begin by heating the alloy slug. Light the candle. Check to see that the flame is steady (if not, stand an open book near to prevent drafts).

Hold the ladle about 1/4" above the tip of the flame.

NOTE: A common mistake is to hold the ladle *in* the flame rather than *above* it. If you hold it in the flame, not only will the heating take longer (it is cooler in the flame than above it), but you will get soot on the ladle—and probably on your clothes, hands, etc., as well.

As soon as you have begun to heat the metal, think through your answer to this question:

What am I to begin to do as soon as all of the metal is melted?

After you have your answer, turn the page.

A good answer: After the metal is all melted, I'll begin counting seconds.

OK. Wait till the metal is *all* melted, then watch your time.

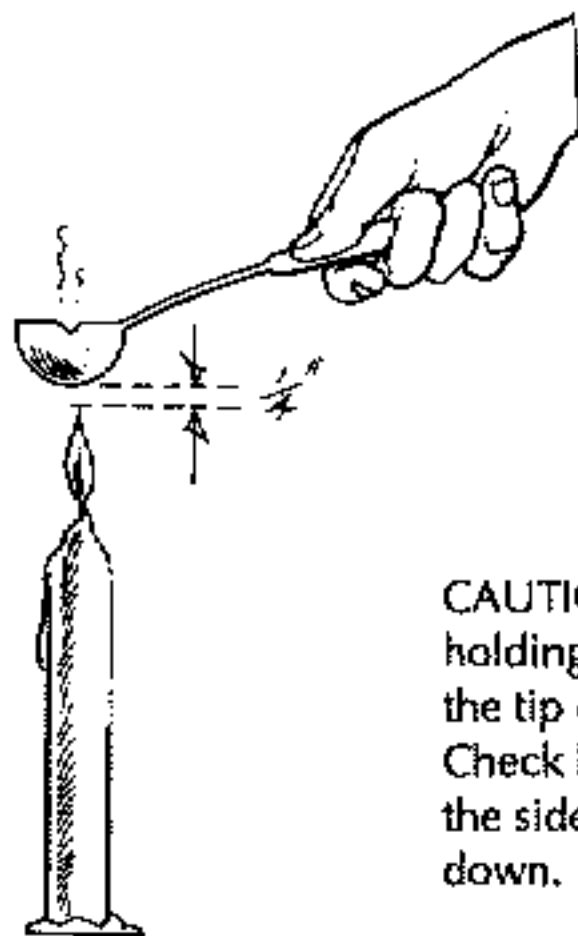

CAUTION: Are you holding the ladle *above* the tip of the flame? Check by looking from the side, not simply down.

What are you going to do after about 20-25 seconds?

After you have thought through your answer, turn the page.

A good answer: After 20-25 seconds, I'm going to hold the mold upside down over the ladle to warm it up for casting.

OK. When your 20-25 seconds are up, hold the mold as shown.

Hold for another 5-10 seconds.

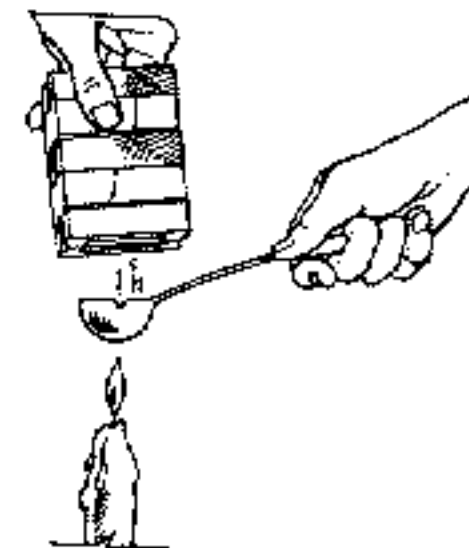

Then, *pour* the metal into the mold and *tap* the mold on the table several times.

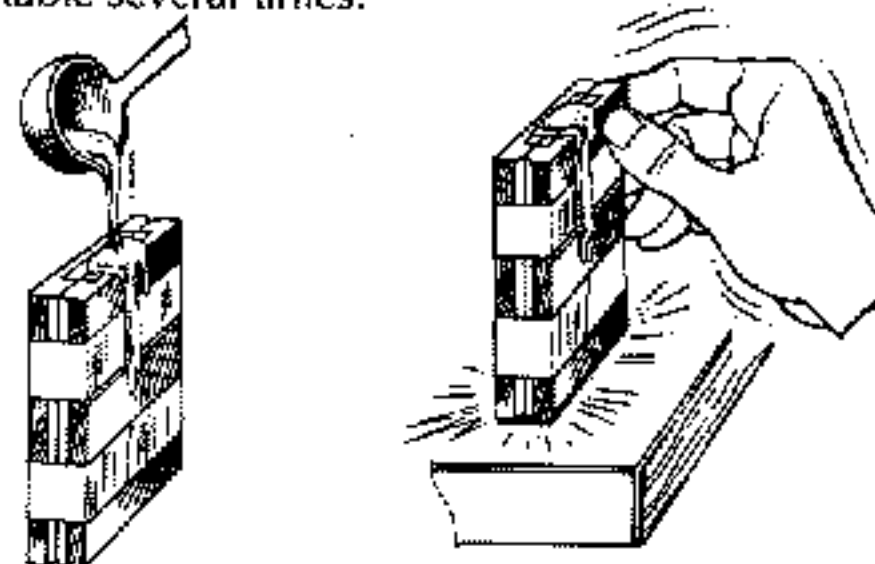

The purpose of tapping the mold on the table is to release any air bubbles and to help the metal flow into small crevices.

NOTE: Don't be surprised if not much metal seems to go into the mold. You may have a small key.

Congratulations! You have now cast the key.

If you poured hot metal on your fingers, you probably discovered that you were more startled than hurt. The metal cools so fast that it is very unlikely to burn.

Now all that remains is:

1. Waiting for the cast to solidify;
2. Removing the cast from the mold; and
3. Inspecting the cast for defects.

Now turn to the next page.

Usually the cast can be expected to solidify within a minute of pouring, but it is good to wait about two minutes before opening the mold.

Imagine you have just cast a rather large key. How long would it be safe to wait before separating the mold-halves?

- A. One minute
- B. Two minutes

After you have decided on your answer, turn the page.

"B" is correct. It would be unsafe to separate the mold after only one minute when casting a large or thick key.

Why?

When you have your answer, turn the page.

A good answer: The large key, having more hot metal, would take longer to cool and therefore longer to solidify.

Once again, two minutes is a reasonably safe time to wait before opening the mold.

The next step is to remove the cast from the mold.

What you do:

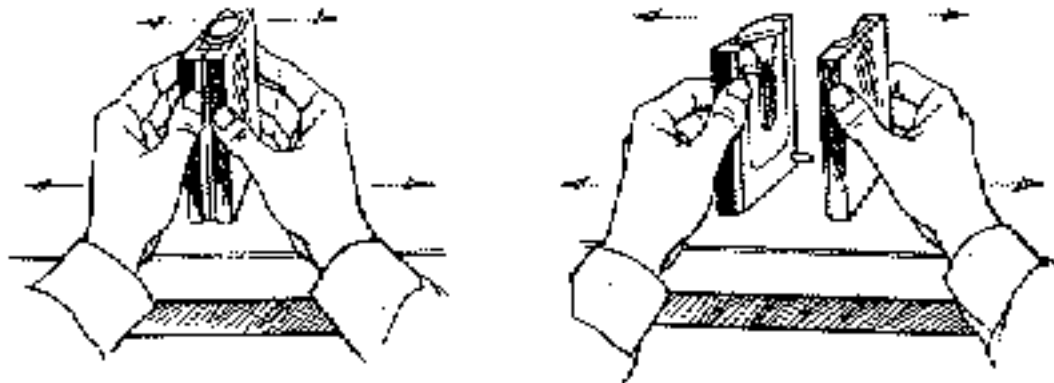

With the mold held vertically, pull the halves apart *carefully*.

You should then put the mold-halves on the table, clay-side up.

Why be careful with the mold *after* the cast has solidified?

When you have your answer, turn the page.

The "right" answer: If you are careful with the mold, then you can use it again to make another good casting.

Why does removing the casting pose more of a problem than removing the key itself?

After you have your answer in mind, turn the page.

A good answer: Removing the casting from the mold poses more of a problem than removing the key itself because the casting, unlike the key, offers nothing to hold on to, nothing to lift with.

To remove the casting:

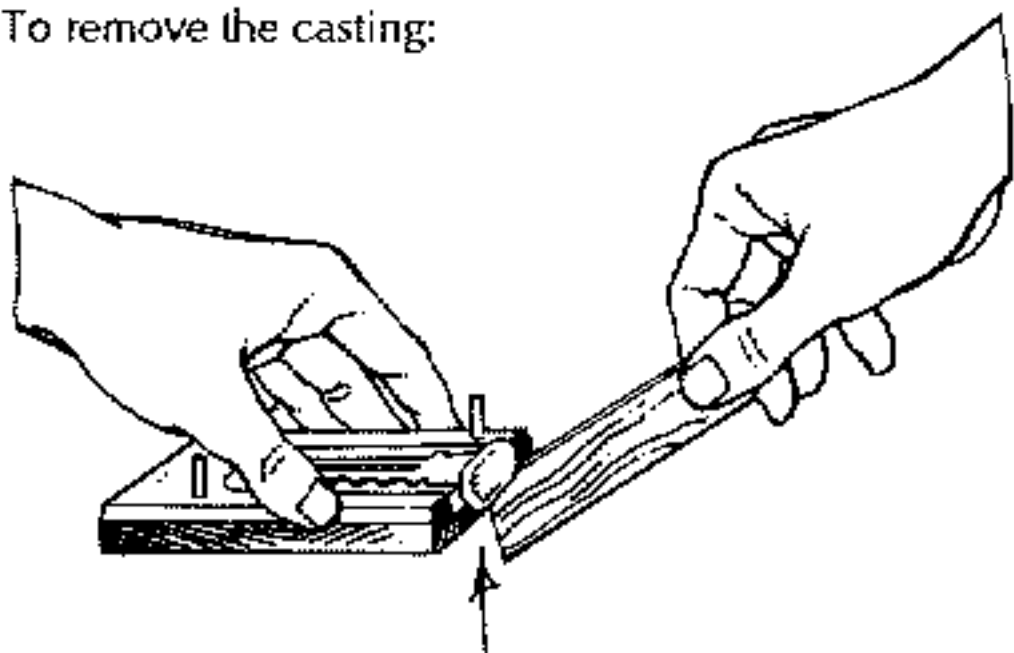

Insert a corner of the scraper under the casting.
Loosen gently.
Remove carefully.

NOTE: If you are *careful* in removing the key casting, you will be able to use the same impression again.

Casting removed? Turn to the next page.

The last step is to inspect the casting for defects. Defects can be divided into two sorts:

1. Absence of biting;
2. Blurring of biting.

Which drawing shows "bitting"?

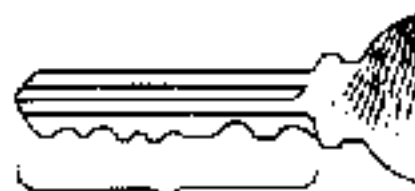

A



B

When you have chosen "A" or "B," turn the page.

NOTE: Frequently, the biting is webbed with *thin sheets of metal*. These sheets result when the clay of the two mold-halves does not close tightly about the key while it is being impressed in the mold. Slight air spaces remain, into which the metal runs during casting. These presence of these thin sheets is *not a defect*, because they can be removed by filing.



CAUTION: Leave the filing to a properly trained technician.

The bitting is shown in drawing A.

Defects can be classified into those involving:

1. Absence of bitting; or
2. Blurring of bitting.

Does this drawing illustrate a defect in casting due to

- A. Absence of bitting, or
- B. Blurring of bitting?

Choose A or B.



Dotted line shows
outline of original key.

Got your answer? Turn the page.

"A" is correct. The defect shown is due to *absence of bitting*.

Blurring has to do with slight inaccuracies in the bitting due to air bubbles or damage to the impression.

Which do these drawings illustrate, defects due to absence of bitting, or defects due to blurring of bitting? Both illustrate the same defect.



- A. Absence of bitting B. Blurring of bitting

When you've chosen A or B, turn the page.

“B” for blurring of biting is correct. The two drawings illustrate small defects of the biting due to tiny air bubbles and carelessness in removing the key after making the impression.

You may remember that such carelessness may be the result of:

1. Twisting the key too much while loosening it;
2. Pushing or pulling the key while loosening it; or
3. Not lifting straight up.

Inspect your own casting by comparing it with the original.

Can you find any defects?

If so, what kind are they?

If so, can you explain them?

Take your time. When you've done a careful inspection, turn the page.

If you could find no defects, you are doing unusually well. It is the rare person whose first casting has no noticeable imperfection.

Let's pretend that your casting had a defect due to absence of biting.

What should you do?

When ready with your answer, turn the page.

If your defect is due to absence of biting, chances are that your mold is OK, and you only need to recast the key, using the same mold. Absence of biting usually results from a bubble of entrapped air or too rapid cooling of the metal, rather than from damage to the mold itself.

NOTE: If you suspect that the defect is due to entrapped air, you may draw a fine line in the clay with the scraper, perhaps 1/2" or more long, leading away from the point in the mold where the defect occurred. This will allow the air to escape and metal to flow into that part of the mold.

NOTE: If you suspect that the defect is due to too rapid cooling of the metal, maybe you're counting seconds too fast and not heating the metal enough. Or maybe you're not holding the ladle the proper distance above the tip of the candle flame. The flame is much hotter at its tip than in the middle.

Let's pretend this time that your casting had a defect due to blurring of biting. In comparing the casting with the original key, you notice some slight irregularities due, you believe, from damage to the impression while you were removing the key.

What should you do in this case?

When ready with your answer, turn the page.

If a defect is due to damage to the impression, you should start all over again—preparing the mold, taking another impression, and recasting.

NOTE: To reprepare the mold, you may either rework the clay already in the mold, or you may remove the old clay and start over with fresh clay.

If you rework the old clay, you should add to it the clay you scraped off and keep pressing *down* with your thumbs until the two chunks are smoothly blended.

If you remove the old clay, you will find the scraper convenient for getting the clay out of the mold-halves. You needn't bother to remove all traces of the old clay before adding the new.

Now that you have cast a key, you are all set to open the lock with what you have produced so lovingly.

Right?

When ready, turn the page.

Answer: No! You are not in a good position yet to open the lock!

Why not?

Ready with your answer? Then turn the page.

Good answers:

The metal is too soft.

There's no bow with which to hold and turn the key.

What must be done before you have a true "duplicate key"?

Thought out your answer? Then turn the page.

Answer: Before you have a true "duplicate key," you must make one of regular key metal (commonly brass). Usually this is done on a standard key duplicating machine.

Congratulations!

You now should be able to use the Key Casting Kit with at least a beginner's skill.

Practice will make you more nearly perfect.

Good luck to you!